

Data Sheet



Article number: 12621000060700

Description: Threaded pin 621 000 060.700
For M6

Measures

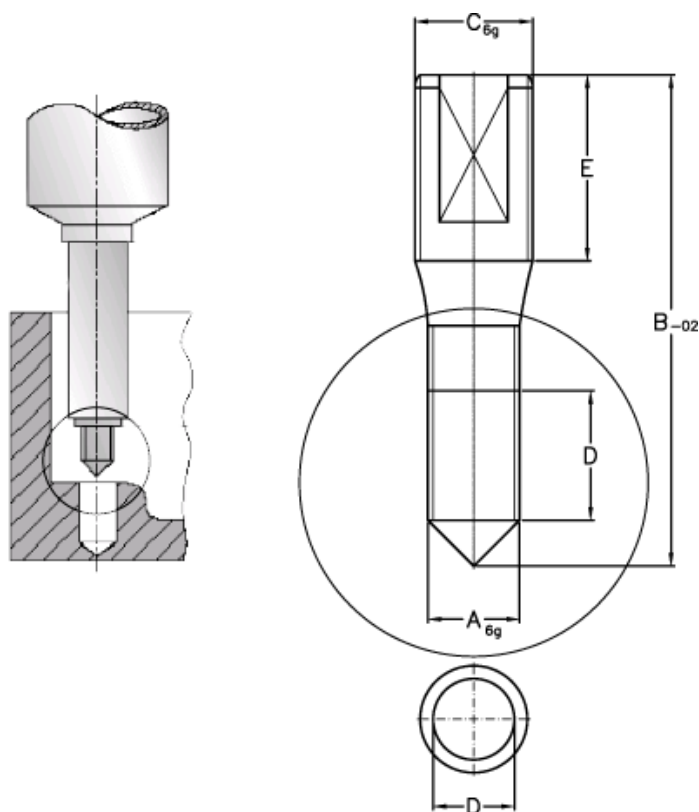

A = M6
B = 92.0
C = M8
D = 12.1
E = 20